



Product Category

45-6-24-S

Part Description

Direct Socketweld/Braze Pipe X Male Straight Thread Adapter

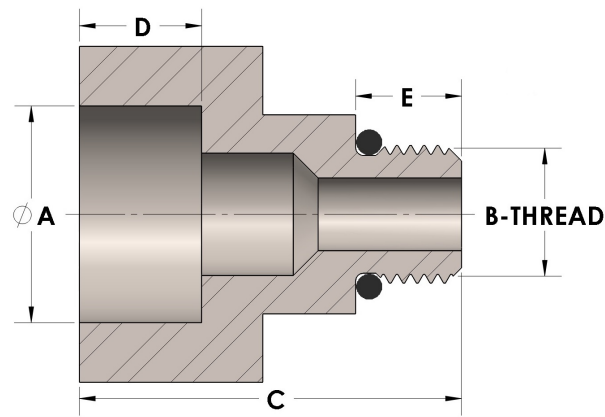

DIMENSIONS

A	1.675
B-THREAD	1.875"-12UN
C	2.00
D	0.690
E	0.63

GENERAL

Pressure Rating	4500 PSI
O-Ring Material	Viton® Fluorocarbon Type 1, Class 2 (90 durometer)
Fitting Material	Carbon Steel, ASTM A108

The complete catalog contents must be reviewed to ensure that the system designer and user make a safe product selection. When selecting products, the total system design must be considered to ensure safe, trouble-free performance. Function, material compatibility, adequate ratings, proper installation, operation, and maintenance are the responsibilities of the system designer and user. Caution: Do not mix or interchange valve components with those of other manufacturers.