

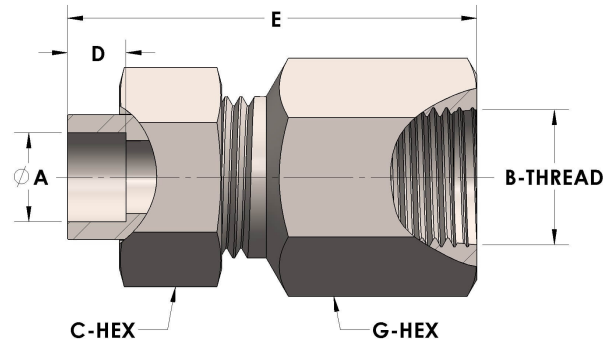

**Product Category**  
**Part Description**

H864-06-08-SS316L  
Tube to Female Straight Thread Union Assembly



## DIMENSIONS

A	0.380
B-THREAD	.750" - 16UNF
C-HEX	0.94
D	0.250
E	1.94
G-HEX	1.06

## GENERAL

Pressure Rating	6000 PSI
Assembly Material	316/L Stainless Steel, ASTM A276, UNS S31600/03
O-Ring Material	Viton® Fluorocarbon Type 1, Class 2 (90 durometer)
Connection 1 Type	Female Tube Socket
Connection 1 Size	3/8" Tube O.D. (-06)
Connection 2 Type	Female Straight Thread
Connection 2 Size	.750" - 16UNF (-08)