

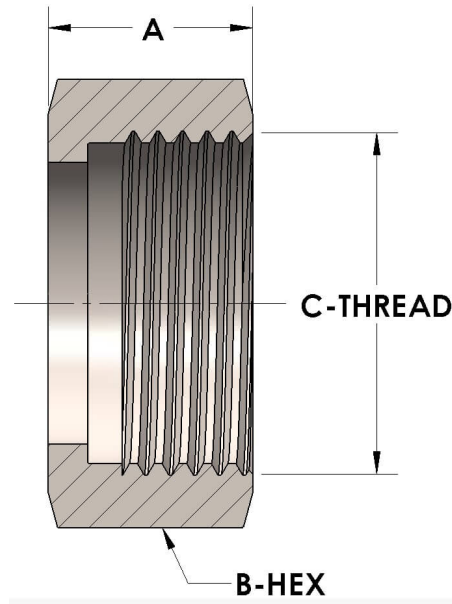

Product Category  
Part Description

H850N-16-BR  
Union Nut



## DIMENSIONS

A	0.750
B-HEX	1.63
C-THREAD	1.500" - 12UNF

## GENERAL

Pressure Rating	3000 PSI
Union Nut Material	Naval Brass, ASTM B21, UNS C46400

The complete catalog contents must be reviewed to ensure that the system designer and user make a safe product selection. When selecting products, the total system design must be considered to ensure safe, trouble-free performance. Function, material compatibility, adequate ratings, proper installation, operation, and maintenance are the responsibilities of the system designer and user. Caution: Do not mix or interchange valve components with those of other manufacturers.