

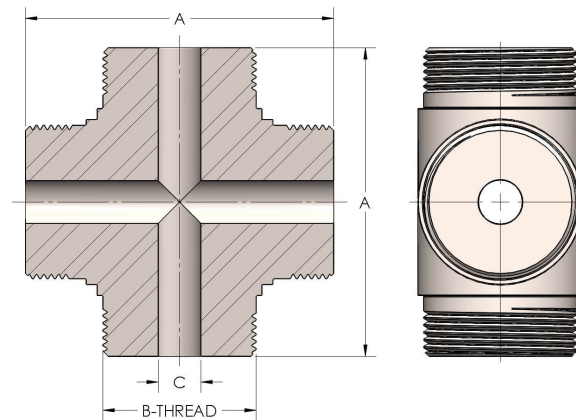

Product Category
Part Description

43-7-NAB
Cross



DIMENSIONS

A	5.750
B-THREAD	3.063" - 12UNS
C	1.38
D	2.880

GENERAL

Pressure Rating	6000 PSI
Threadpiece Material	Nickel Aluminum Bronze, ASTM B148, UNS C95800

The complete catalog contents must be reviewed to ensure that the system designer and user make a safe product selection. When selecting products, the total system design must be considered to ensure safe, trouble-free performance. Function, material compatibility, adequate ratings, proper installation, operation, and maintenance are the responsibilities of the system designer and user. Caution: Do not mix or interchange valve components with those of other manufacturers.