



Product Category

41-8-NAB

Part Description

Elbow 90°

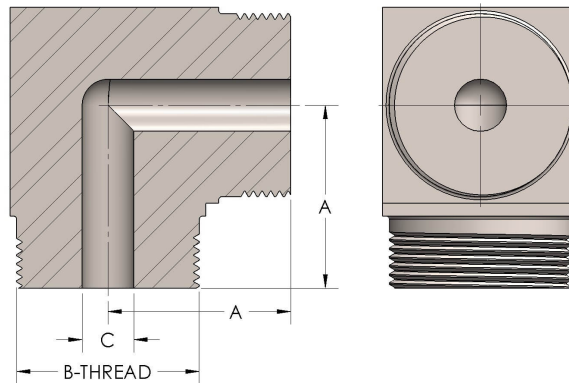

## DIMENSIONS

A	3.250
B-THREAD	3.750" - 12UN
C	1.75

## GENERAL

Pressure Rating	6000 PSI
Threadpiece Material	Nickel Aluminum Bronze, ASTM B148, UNS C95800

The complete catalog contents must be reviewed to ensure that the system designer and user make a safe product selection. When selecting products, the total system design must be considered to ensure safe, trouble-free performance. Function, material compatibility, adequate ratings, proper installation, operation, and maintenance are the responsibilities of the system designer and user. Caution: Do not mix or interchange valve components with those of other manufacturers.