



Product Category

Part Description

89T-6-M

Bulkhead

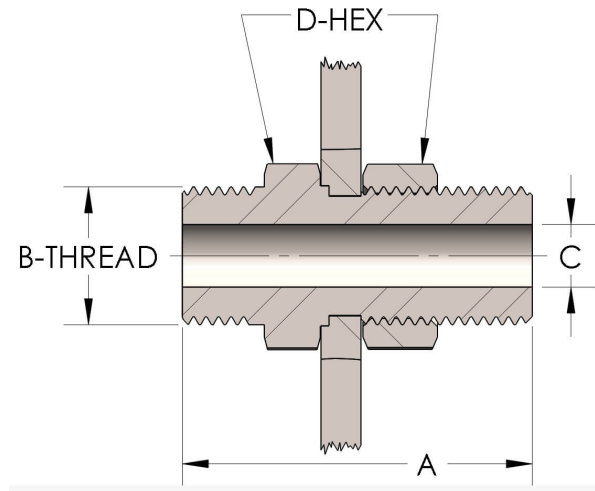

DIMENSIONS

A	2.940
B-THREAD	2.750" - 12UN
C	1.19
D-HEX	3.25

GENERAL

Pressure Rating	6000 PSI
Threadpiece Material	Monel®, ASTM B164, UNS N04405

The complete catalog contents must be reviewed to ensure that the system designer and user make a safe product selection. When selecting products, the total system design must be considered to ensure safe, trouble-free performance. Function, material compatibility, adequate ratings, proper installation, operation, and maintenance are the responsibilities of the system designer and user. Caution: Do not mix or interchange valve components with those of other manufacturers.