



Product Category

Part Description

48R-2-BR

Socketweld Tube

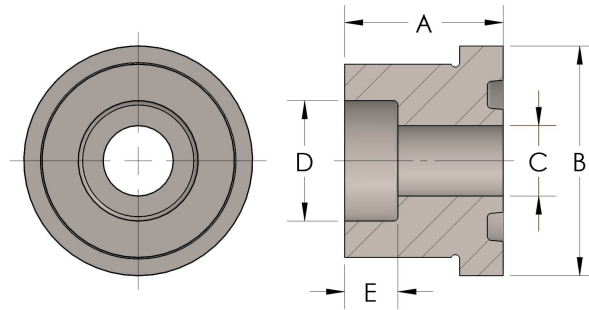

DIMENSIONS

A	1.130
B	1.25
C	0.44
D	0.500
E	0.44

GENERAL

Pressure Rating	6000 PSI
Tailpiece Material	Naval Brass, ASTM B21, UNS C46400
O-Ring Material	Viton® Fluorocarbon Type 1, Class 2 (90 durometer)

The complete catalog contents must be reviewed to ensure that the system designer and user make a safe product selection. When selecting products, the total system design must be considered to ensure safe, trouble-free performance. Function, material compatibility, adequate ratings, proper installation, operation, and maintenance are the responsibilities of the system designer and user. Caution: Do not mix or interchange valve components with those of other manufacturers.