

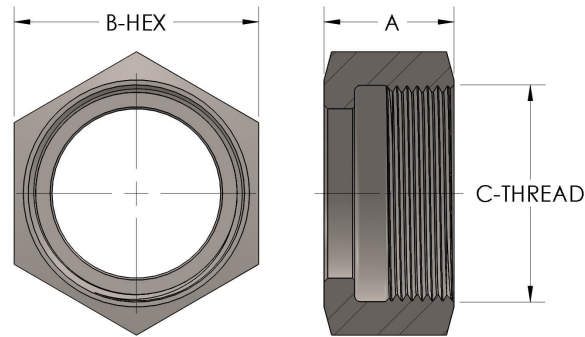

Product Category
Part Description

884P8-9-NAB
Union Nut IAW NSSC 803-1385884



DIMENSIONS

A	1.880
B-HEX	5.13
CRN	0A16860.2
C-THREAD	4.500" - 12UN

GENERAL

Pressure Rating	6000 PSI
Union Nut Material	Nickel Aluminum Bronze, ASTM B148, UNS C95800
CRN	0A16860.2

The complete catalog contents must be reviewed to ensure that the system designer and user make a safe product selection. When selecting products, the total system design must be considered to ensure safe, trouble-free performance. Function, material compatibility, adequate ratings, proper installation, operation, and maintenance are the responsibilities of the system designer and user. Caution: Do not mix or interchange valve components with those of other manufacturers.