

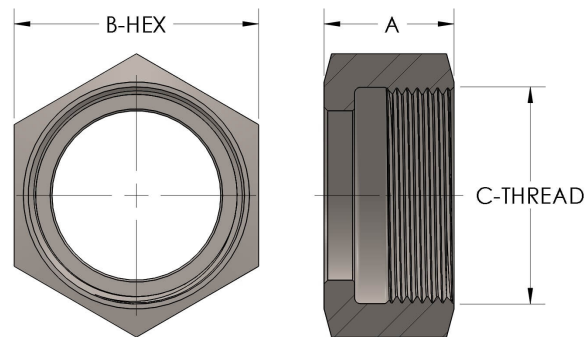

Product Category
Part Description

884P8-8-SS316L
Union Nut IAW NSSC 803-1385884



DIMENSIONS

A	1.500
B-HEX	4.38
CRN	0A16860.2
C-THREAD	3.750" - 12UN

GENERAL

Pressure Rating	6000 PSI
Union Nut Material	316/L Stainless Steel, ASTM A276, UNS S31600/03
CRN	0A16860.2

The complete catalog contents must be reviewed to ensure that the system designer and user make a safe product selection. When selecting products, the total system design must be considered to ensure safe, trouble-free performance. Function, material compatibility, adequate ratings, proper installation, operation, and maintenance are the responsibilities of the system designer and user. Caution: Do not mix or interchange valve components with those of other manufacturers.