

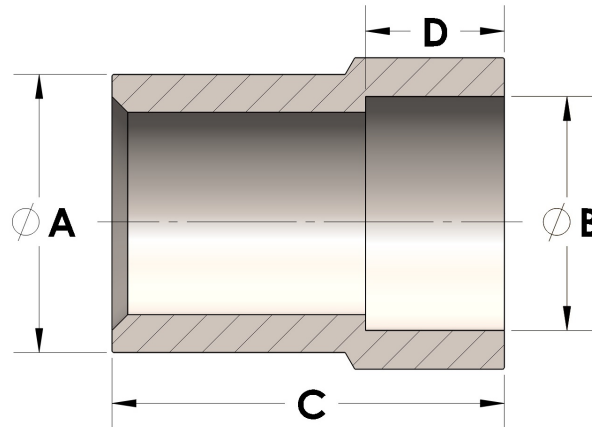

Product Category
Part Description

H866-20-12-SS316L
Direct Weld/Braze Insert (Male Tube X Pipe SW)



DIMENSIONS

A	1.250
B	1.06
C	1.75
D	0.500

GENERAL

Pressure Rating	4500 PSI
Fitting Material	316/L Stainless Steel, ASTM A276, UNS S31600/03

The complete catalog contents must be reviewed to ensure that the system designer and user make a safe product selection. When selecting products, the total system design must be considered to ensure safe, trouble-free performance. Function, material compatibility, adequate ratings, proper installation, operation, and maintenance are the responsibilities of the system designer and user. Caution: Do not mix or interchange valve components with those of other manufacturers.