

Product Category

100-0-M

Part Description

Direct Socketweld/Braze Coupling (Pipe)

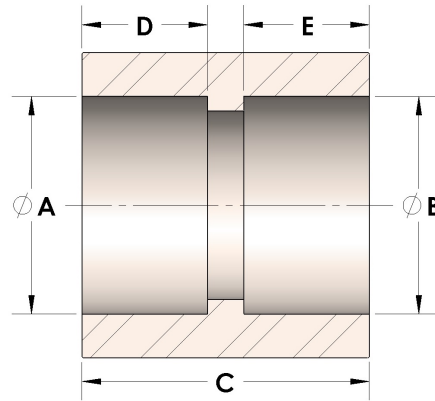

## DIMENSIONS

A	0.420
B	0.42
C	1.06
D	0.380
E	0.38

## GENERAL

Pressure Rating	6000 PSI
Fitting Material	Monel®, ASTM B164, UNS N04405