

Product Category

100-1-0-CUNI

Part Description

Direct Socketweld/Braze Coupling (Pipe)

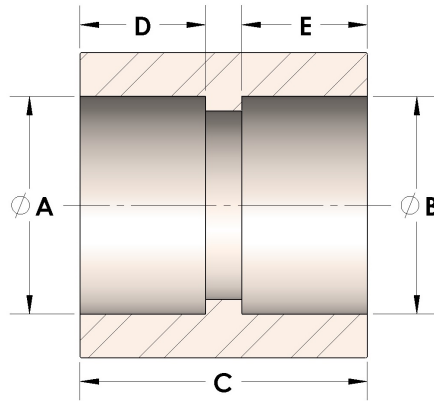

## DIMENSIONS

A	0.555
B	0.42
C	1.19
D	0.380
E	0.38

## GENERAL

Pressure Rating	4500 PSI
Fitting Material	Copper Nickel 70/30, MIL-C--15726F, UNS C71500