

Product Category

100-1-S

Part Description

Direct Socketweld/Braze Coupling (Pipe)

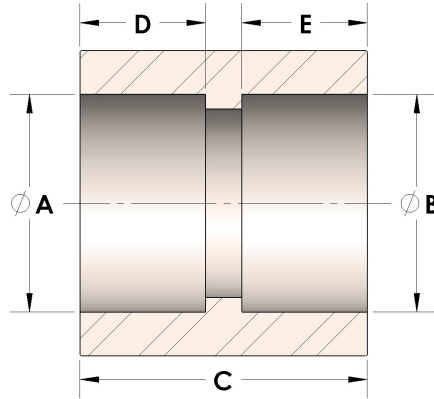

## DIMENSIONS

A	0.555
B	0.56
C	1.06
D	0.380
E	0.38

## GENERAL

Pressure Rating	6000 PSI
Fitting Material	Carbon Steel, ASTM A108