

Product Category

100-3-2-SS316L

Part Description

Direct Socketweld/Braze Coupling (Pipe)

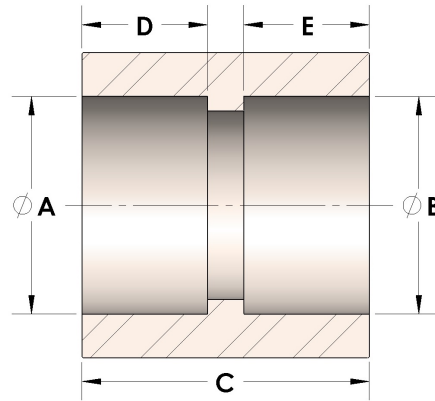

DIMENSIONS

A	0.855
B	0.69
C	1.38
D	0.500
E	0.44

GENERAL

Pressure Rating	6000 PSI
Fitting Material	316/L Stainless Steel, ASTM A276, UNS S31600/03