

Product Category

100-5-CUNI

Part Description

Direct Socketweld/Braze Coupling (Pipe)

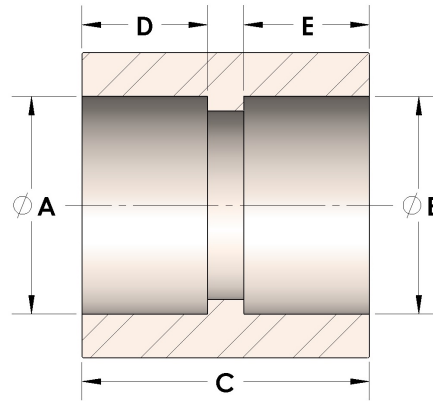

DIMENSIONS

A	1.330
B	1.33
C	1.50
D	0.500
E	0.50

GENERAL

Pressure Rating	4500 PSI
Fitting Material	Copper Nickel 70/30, MIL-C--15726F, UNS C71500