

Product Category

100-8-CUNI

Part Description

Direct Socketweld/Braze Coupling (Pipe)

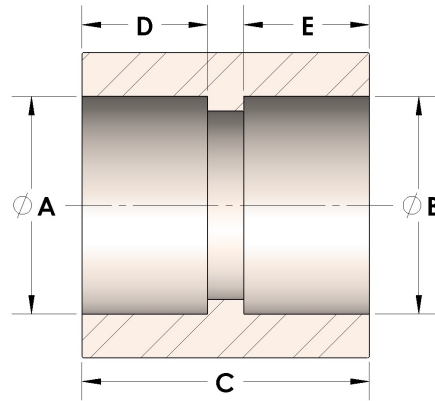

DIMENSIONS

A	2.406
B	2.41
C	2.00
D	0.630
E	0.63

GENERAL

Pressure Rating	3000 PSI
Fitting Material	Copper Nickel 70/30, MIL-C--15726F, UNS C71500