

Product Category

100-8-M

Part Description

Direct Socketweld/Braze Coupling (Pipe)

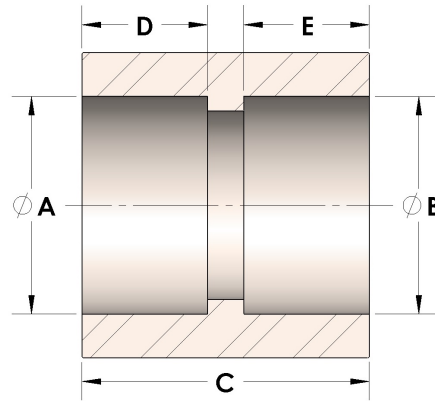

DIMENSIONS

A	2.406
B	2.41
C	2.00
D	0.630
E	0.63

GENERAL

Pressure Rating	6000 PSI
Fitting Material	Monel®, ASTM B164, UNS N04405