

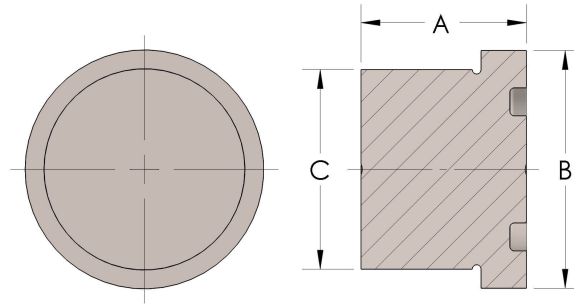

Product Category
Part Description

104R-1-CUNI
Blank



DIMENSIONS

A	1.060
B	1.06
C	0.87

GENERAL

Pressure Rating	6000 PSI
Tailpiece Material	Copper Nickel 70/30, MIL-C--15726F, UNS C71500
O-Ring Material	Viton® Fluorocarbon Type 1, Class 2 (90 durometer)

cpvmfg.com | 484.731.4010

The complete catalog contents must be reviewed to ensure that the system designer and user make a safe product selection. When selecting products, the total system design must be considered to ensure safe, trouble-free performance. Function, material compatibility, adequate ratings, proper installation, operation, and maintenance are the responsibilities of the system designer and user. Caution: Do not mix or interchange valve components with those of other manufacturers.