

Product Category

107-2-06-S

Part Description

Direct Socketweld/Braze Coupling (Pipe X Tube)

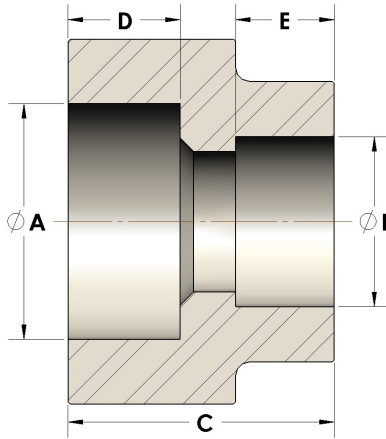

DIMENSIONS

A	0.680
B	0.38
C	0.94
D	0.380

GENERAL

Pressure Rating	6000 PSI
Fitting Material	Carbon Steel, ASTM A108