

Product Category

107-3-08-CUNI

Part Description

Direct Socketweld/Braze Coupling (Pipe X Tube)

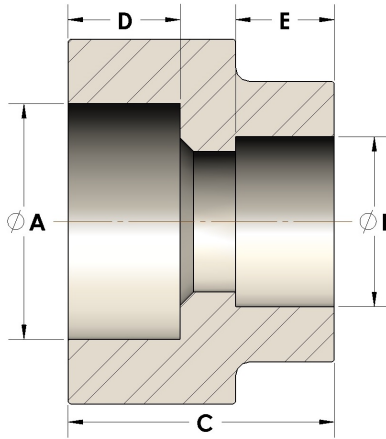

## DIMENSIONS

A	0.845
B	0.50
C	1.00
D	0.440

## GENERAL

Pressure Rating	3000 PSI
Fitting Material	Copper Nickel 70/30, MIL-C--15726F, UNS C71500