

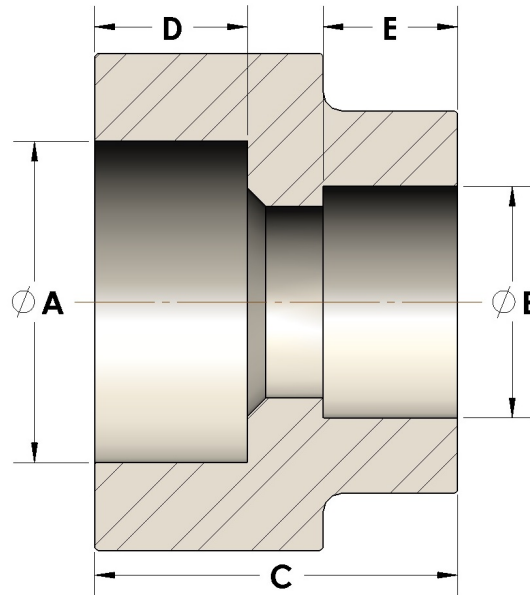

Product Category
Part Description

107-5-08-S
Direct Socketweld/Braze Coupling (Pipe X Tube)



DIMENSIONS

A	1.320
B	0.50
C	1.31
D	0.560

GENERAL

Pressure Rating	6000 PSI
Fitting Material	Carbon Steel, ASTM A108

The complete catalog contents must be reviewed to ensure that the system designer and user make a safe product selection. When selecting products, the total system design must be considered to ensure safe, trouble-free performance. Function, material compatibility, adequate ratings, proper installation, operation, and maintenance are the responsibilities of the system designer and user. Caution: Do not mix or interchange valve components with those of other manufacturers.