

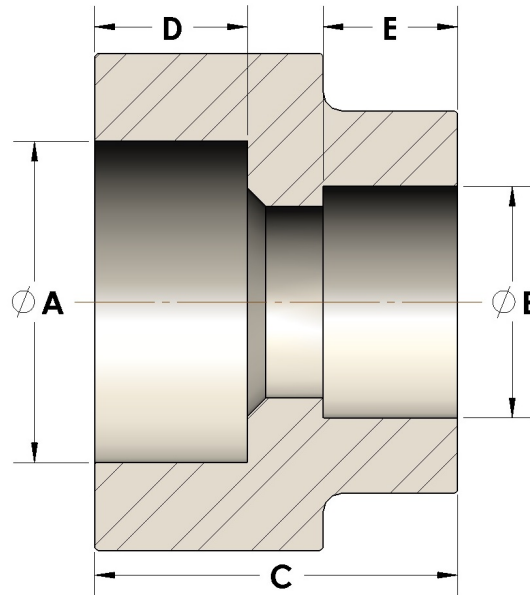

Product Category
Part Description

107-5-10-M
Direct Socketweld/Braze Coupling (Pipe X Tube)



DIMENSIONS

| | |
|---|-------|
| A | 1.320 |
| B | 0.63 |
| C | 1.31 |
| D | 0.560 |

GENERAL

| | |
|------------------|-------------------------------|
| Pressure Rating | 6000 PSI |
| Fitting Material | Monel®, ASTM B164, UNS N04405 |

The complete catalog contents must be reviewed to ensure that the system designer and user make a safe product selection. When selecting products, the total system design must be considered to ensure safe, trouble-free performance. Function, material compatibility, adequate ratings, proper installation, operation, and maintenance are the responsibilities of the system designer and user. Caution: Do not mix or interchange valve components with those of other manufacturers.