



Product Category

11D-C-B-R

Product Line

Cast Iron & Bronze Flanged Check Valves (10D, 11D, 12D, 13D, 20D, 21D)

Part Description

CLASS 250 Flange Style Silent Check Valve with Cast Iron Body and Bronze Trim

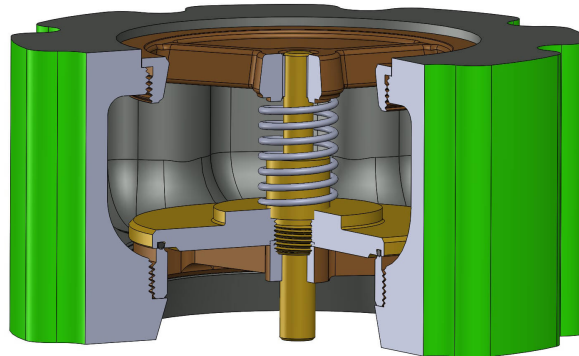

DIMENSIONS

Face to Face	3.13
Dia. of Bolt Circle	6.63
Dia. of Flange	8.25
No. of Studs	8
Dia. of Studs	0.75
Length of Studs	8.50
Weight (lbs.)	15

GENERAL

Pressure Rating	up to 500 PSI
Temperature Range	-30°F to 250°F (-34°C to 121°C)
Standard Soft Goods	Buna-N O-Rings
Cartridge Type	Check
Connection Type	ANSI B16.5 Flange
Connection Size	3"
Body Material	Cast Iron, ASTM A126, CL. B

OPTIONS

Port & Vent Options	[-DP] Drain Plug Above Seat (1/2" NPT)
---------------------	--

The complete catalog contents must be reviewed to ensure that the system designer and user make a safe product selection. When selecting products, the total system design must be considered to ensure safe, trouble-free performance. Function, material compatibility, adequate ratings, proper installation, operation, and maintenance are the responsibilities of the system designer and user. Caution: Do not mix or interchange valve components with those of other manufacturers.