



Product Category

1380-3-NC

Product Line

FloMaster® Actuated O-SEAL® Shutoff Valve (1300 Series)

Part Description

1/2" Globe Shutoff Actuated Valve, O-SEAL® Ends, Normally Closed

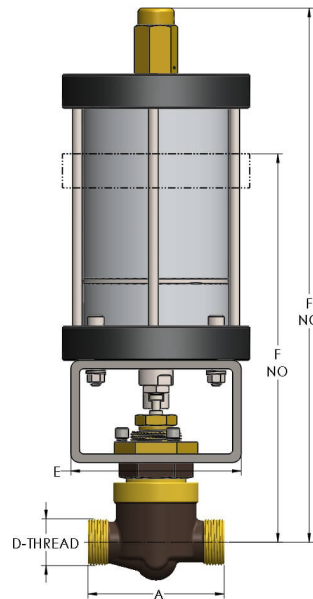

## DIMENSIONS

Port Dia.	0.5
A	4.250
CRN	0C17716.2
D-THREAD	1.750"-12UN
E	6.00
F (Normally Closed)	18.56

## GENERAL

Pressure Rating	6000 PSI
Temperature Range	-15°F to 400°F (-26°C to 204°C)
Standard Soft Goods	[-G] Polyurethane® Packing and Viton® O-Rings
Cartridge Type	Shutoff
Connection Type	O-SEAL® Union Thread

<b>Connection Size</b>	1/2"
<b>Body Material</b>	Nickel Aluminum Bronze, ASTM B148, UNS C95800
<b>Bonnet Material</b>	Nickel Aluminum Bronze, ASTM B150, UNS C63200
<b>CRN</b>	0C17716.2

## OPTIONS

<b>[-VC] Vacuum Service</b>	Option to add additional softgoods for internal vacuum service.
<b>Port &amp; Vent Options</b>	[-PA] Port Above Seat (1/8" NPT), [-PB] Port Below Seat (1/8" NPT), '[-VA] Vent Above Seat (3/8"-24 SAE), [-VB] Vent Below Seat (3/8"-24 SAE),
<b>Optional Soft Goods</b>	[-B] Polyurethane® Packing and Buna-N O-Rings, [-C] Viton® Packing & O-Rings, [-D] EPDM Packing & O-Rings

cpvmfg.com | 484.731.4010

The complete catalog contents must be reviewed to ensure that the system designer and user make a safe product selection. When selecting products, the total system design must be considered to ensure safe, trouble-free performance. Function, material compatibility, adequate ratings, proper installation, operation, and maintenance are the responsibilities of the system designer and user. Caution: Do not mix or interchange valve components with those of other manufacturers.