

Product Category

151-4

Product Line

NPT Threaded Relief Valves (150 Series)

Part Description

Steel Angle Relief Valve with Female Pipe Thread (NPT) Ends

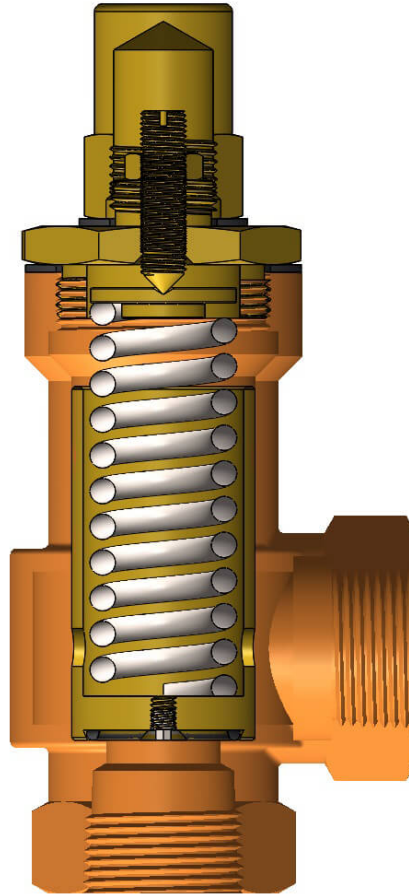

DIMENSIONS

Overall Length	6.25
Female Inlet and Outlet (NPT)	3/4"-14
Center of Outlet to Bottom	1.75
Weight (lbs.)	3.8



GENERAL

Pressure Rating	300 PSI
Temperature Range	-30°F to 250°F (-34°C to 121°C)
Standard Soft Goods	Buna-N O-Rings
Cartridge Type	Relief
Connection Type	Female Pipe Thread (NPT)
Connection Size	3/4"
Body Material	Carbon Steel, ASTM A36/A311, UNS K02600/G10180
Bonnet Material	Carbon Steel, ASTM A36/A311, UNS K02600/G10180

OPTIONS

Optional Soft Goods	Viton® O-Rings, EPDM O-Rings
----------------------------	------------------------------