

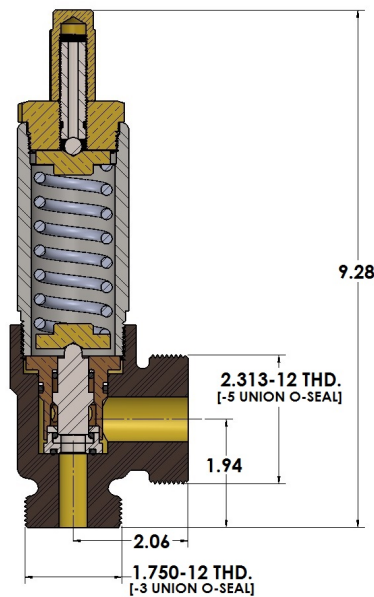

Product Category
Product Line
Part Description

158-0.156-
O-SEAL® Compact Relief Valves (158 Series)
Angle Relief Valve with -3 x -5 O-SEAL® Ends



GENERAL

Pressure Rating	Range: 135 PSI to 6000 PSI
Temperature Range	-15°F to 400°F (-26°C to 204°C)
Standard Soft Goods	Viton® O-Rings
Cartridge Type	Relief
Connection Type	O-SEAL® Union Thread
Connection Size	-3 x -5
Body Material	Nickel Aluminum Bronze, ASTM B148, UNS C95800
Bonnet Material	Naval Brass, ASTM B21, UNS C46400

OPTIONS

Optional Soft Goods	Buna-N O-Rings, EPDM O-Rings
---------------------	------------------------------

The complete catalog contents must be reviewed to ensure that the system designer and user make a safe product selection. When selecting products, the total system design must be considered to ensure safe, trouble-free performance. Function, material compatibility, adequate ratings, proper installation, operation, and maintenance are the responsibilities of the system designer and user. Caution: Do not mix or interchange valve components with those of other manufacturers.