



Product Category

17D-A-B-R

Product Line

Air Check Valves (14D, 15D, 16D, 17D, 125D, 126D)

Part Description

CLASS 300 Flange Style Silent Air Check Valve with Bronze Body and Bronze Trim

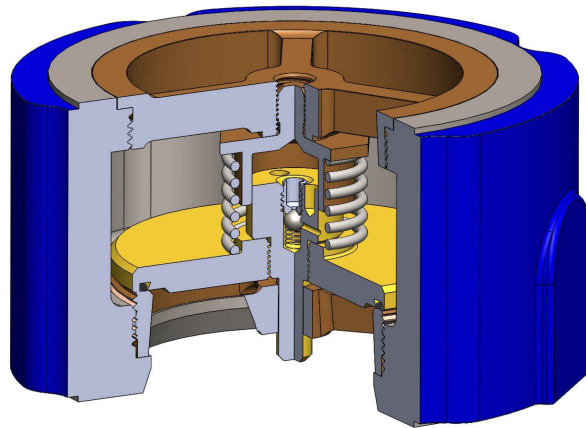

DIMENSIONS

Face to Face	2.63
Dia. of Bolt Circle	5.00
Dia. of Flange	6.50
No. of Studs	8
Dia. of Studs	0.63
Length of Studs	7.00
Weight (lbs.)	8

GENERAL

Pressure Rating	up to 750 PSI
Temperature Range	-30°F to 250°F (-34°C to 121°C)
Standard Soft Goods	Buna-N O-Rings
Cartridge Type	Air Check
Connection Type	ANSI B16.5 Flange
Connection Size	2"
Body Material	Valve Bronze, ASTM B61, UNS C92200

OPTIONS

Port & Vent Options

[-DP] Drain Plug Above Seat (3/8" NPT)

Optional Soft Goods

Viton® O-Rings, EPDM O-Rings

cpvmfg.com | 484.731.4010

The complete catalog contents must be reviewed to ensure that the system designer and user make a safe product selection. When selecting products, the total system design must be considered to ensure safe, trouble-free performance. Function, material compatibility, adequate ratings, proper installation, operation, and maintenance are the responsibilities of the system designer and user. Caution: Do not mix or interchange valve components with those of other manufacturers.