

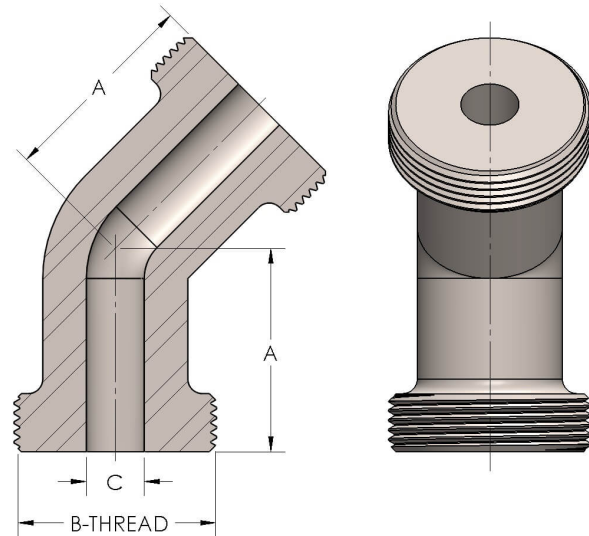

Product Category  
Part Description

42-2-S  
Elbow 45°



## DIMENSIONS

A	1.500
B-THREAD	1.375" - 12UNF
C	0.44

## GENERAL

Pressure Rating	6000 PSI
Threadpiece Material	Steel, ASTM A216-WCB, UNS J03002

The complete catalog contents must be reviewed to ensure that the system designer and user make a safe product selection. When selecting products, the total system design must be considered to ensure safe, trouble-free performance. Function, material compatibility, adequate ratings, proper installation, operation, and maintenance are the responsibilities of the system designer and user. Caution: Do not mix or interchange valve components with those of other manufacturers.