

Product Category

42-4-S

Part Description

Elbow 45°

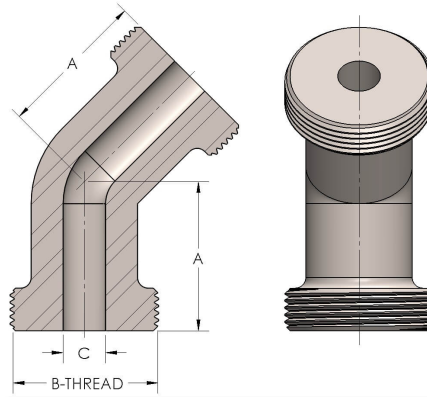

DIMENSIONS

A	1.880
B-THREAD	2.000" - 12UN
C	0.63

GENERAL

Pressure Rating	6000 PSI
Threadpiece Material	Steel, ASTM A216-WCB, UNS J03002