

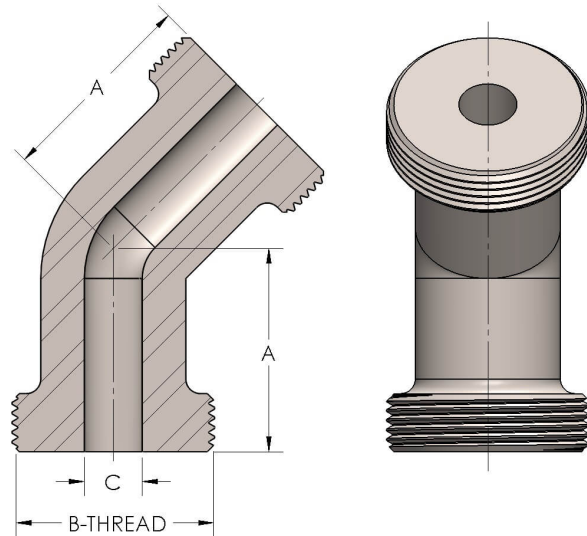

Product Category
Part Description

42-7-SS316L
Elbow 45°



DIMENSIONS

A	2.880
B-THREAD	3.063" - 12UNS
C	1.38

GENERAL

Pressure Rating	6000 PSI
Threadpiece Material	316 Stainless Steel, ASTM A351, UNS J92900

The complete catalog contents must be reviewed to ensure that the system designer and user make a safe product selection. When selecting products, the total system design must be considered to ensure safe, trouble-free performance. Function, material compatibility, adequate ratings, proper installation, operation, and maintenance are the responsibilities of the system designer and user. Caution: Do not mix or interchange valve components with those of other manufacturers.