

Product Category

43-0-S

Part Description

Cross

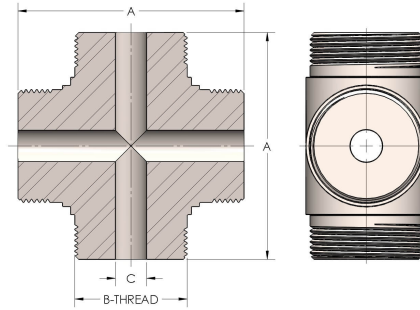

DIMENSIONS

A	2.250
B-THREAD	1.000" - 14UNS
C	0.22
D	1.130

GENERAL

Pressure Rating	6000 PSI
Threadpiece Material	Steel, ASTM A216-WCB, UNS J03002