

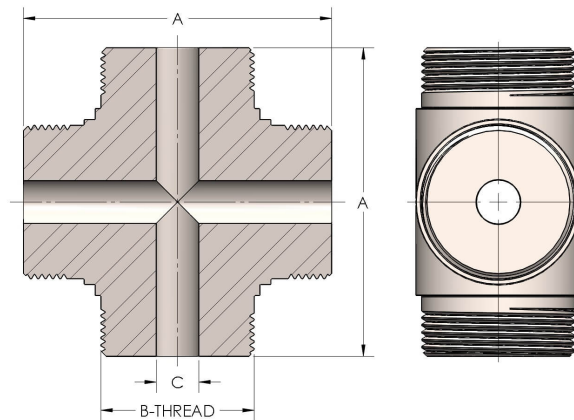

Product Category
Part Description

43-3-SS316L
Cross



DIMENSIONS

A	3.500
B-THREAD	1.750" - 12UN
C	0.50
D	1.750

GENERAL

Pressure Rating	6000 PSI
Threadpiece Material	316 Stainless Steel, ASTM A351, UNS J92900

The complete catalog contents must be reviewed to ensure that the system designer and user make a safe product selection. When selecting products, the total system design must be considered to ensure safe, trouble-free performance. Function, material compatibility, adequate ratings, proper installation, operation, and maintenance are the responsibilities of the system designer and user. Caution: Do not mix or interchange valve components with those of other manufacturers.