

Product Category

43-7-SS316L

Part Description

Cross

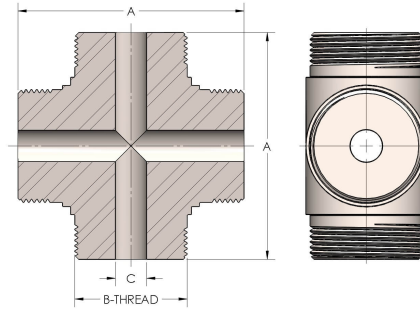

## DIMENSIONS

<b>A</b>	5.750
<b>B-THREAD</b>	3.063" - 12UNS
<b>C</b>	1.38
<b>D</b>	2.880

## GENERAL

<b>Pressure Rating</b>	6000 PSI
<b>Threadpiece Material</b>	316 Stainless Steel, ASTM A351, UNS J92900