

Product Category

43-8-SS316L

Part Description

Cross

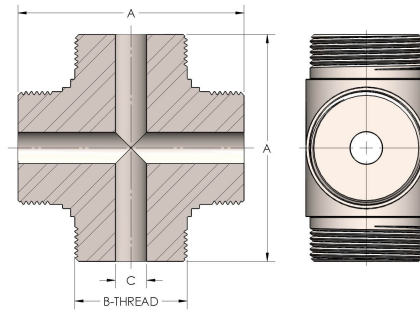

DIMENSIONS

A	6.250
B-THREAD	3.750" - 12UN
C	1.75
D	3.250

GENERAL

Pressure Rating	6000 PSI
Threadpiece Material	316 Stainless Steel, ASTM A351, UNS J92900