



Product Category

45-1-10-M

Part Description

Direct Socketweld/Braze Pipe X Male Straight Thread Adapter

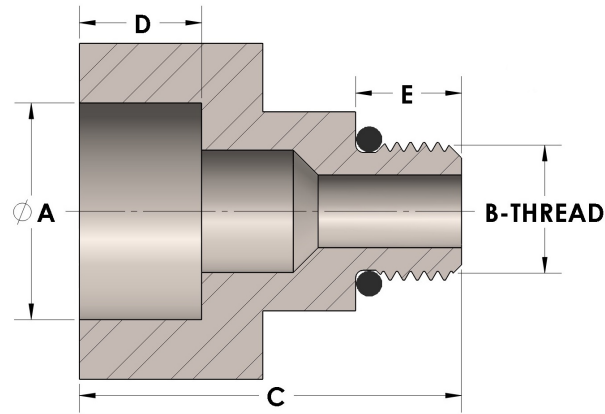

DIMENSIONS

A	0.555
B-THREAD	.875"-14UNF
C	1.63
D	0.380
E	0.53

GENERAL

Pressure Rating	6000 PSI
O-Ring Material	Viton® Fluorocarbon Type 1, Class 2 (90 durometer)
Fitting Material	Monel®, ASTM B164, UNS N04405

The complete catalog contents must be reviewed to ensure that the system designer and user make a safe product selection. When selecting products, the total system design must be considered to ensure safe, trouble-free performance. Function, material compatibility, adequate ratings, proper installation, operation, and maintenance are the responsibilities of the system designer and user. Caution: Do not mix or interchange valve components with those of other manufacturers.