

Product Category

45-3-10-SS316L

Part Description

Direct Socketweld/Braze Pipe X Male Straight Thread Adapter

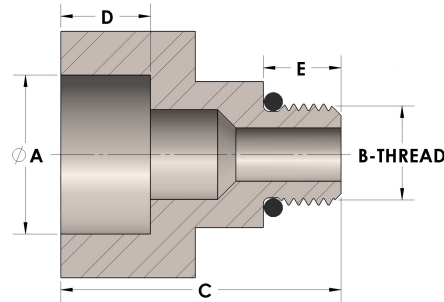

DIMENSIONS

A	0.855
B-THREAD	.875"-14UNF
C	1.75
D	0.500
E	0.53

GENERAL

Pressure Rating	6000 PSI
O-Ring Material	Viton® Fluorocarbon Type 1, Class 2 (90 durometer)
Fitting Material	316/L Stainless Steel, ASTM A276, UNS S31600/03