

Product Category

45-4-16-M

Part Description

Direct Socketweld/Braze Pipe X Male Straight Thread Adapter

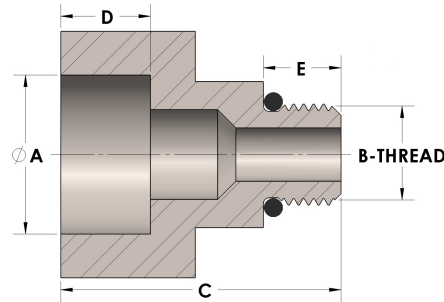

## DIMENSIONS

A	1.065
B-THREAD	1.313"-12UN
C	1.50
D	0.500
E	0.63

## GENERAL

Pressure Rating	6000 PSI
O-Ring Material	Viton® Fluorocarbon Type 1, Class 2 (90 durometer)
Fitting Material	Monel®, ASTM B164, UNS N04405