

Product Category

45-5-10-S

Part Description

Direct Socketweld/Braze Pipe X Male Straight Thread Adapter

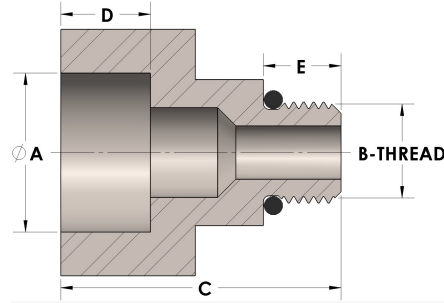

## DIMENSIONS

A	1.330
B-THREAD	.875"-14UNF
C	1.88
D	0.630
E	0.53

## GENERAL

Pressure Rating	6000 PSI
O-Ring Material	Viton® Fluorocarbon Type 1, Class 2 (90 durometer)
Fitting Material	Carbon Steel, ASTM A108