

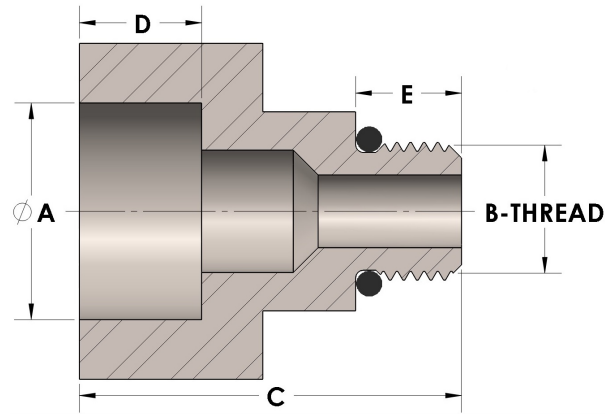

Product Category  
Part Description

45-7-16-SS316L  
Direct Socketweld/Braze Pipe X Male Straight Thread Adapter



## DIMENSIONS

A	1.915
B-THREAD	1.313"-12UN
C	1.88
D	0.500
E	0.63

## GENERAL

Pressure Rating	4500 PSI
O-Ring Material	Viton® Fluorocarbon Type 1, Class 2 (90 durometer)
Fitting Material	316/L Stainless Steel, ASTM A276, UNS S31600/03

The complete catalog contents must be reviewed to ensure that the system designer and user make a safe product selection. When selecting products, the total system design must be considered to ensure safe, trouble-free performance. Function, material compatibility, adequate ratings, proper installation, operation, and maintenance are the responsibilities of the system designer and user. Caution: Do not mix or interchange valve components with those of other manufacturers.