

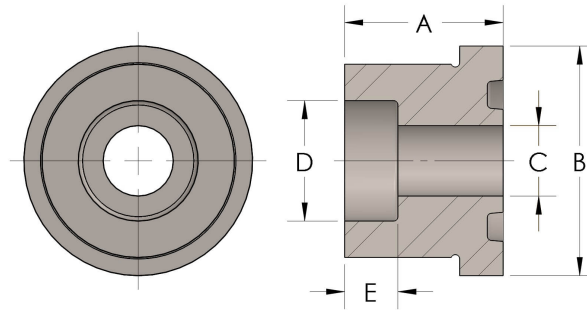

Product Category
Part Description

48R-7-S
Socketweld Tube



DIMENSIONS

A	1.630
B	2.94
C	1.38
D	2.000
E	0.75

GENERAL

Pressure Rating	4500 PSI
Tailpiece Material	Carbon Steel, ASTM A108
O-Ring Material	Viton® Fluorocarbon Type 1, Class 2 (90 durometer)

The complete catalog contents must be reviewed to ensure that the system designer and user make a safe product selection. When selecting products, the total system design must be considered to ensure safe, trouble-free performance. Function, material compatibility, adequate ratings, proper installation, operation, and maintenance are the responsibilities of the system designer and user. Caution: Do not mix or interchange valve components with those of other manufacturers.