

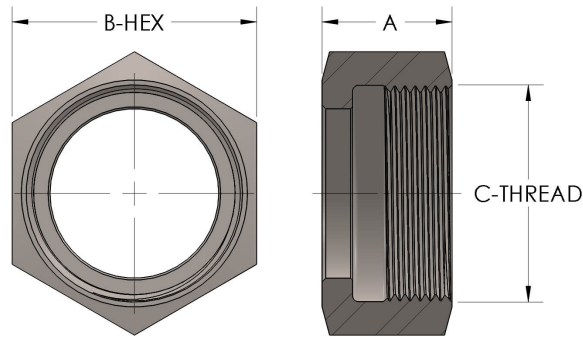

Product Category
Part Description

50N-4-M
Union Nut



DIMENSIONS

A	1.060
B-HEX	2.25
C-THREAD	2.000" - 12UN

GENERAL

Pressure Rating	6000 PSI
Union Nut Material	Monel®, ASTM B164, UNS N04405

cpvmfg.com | 484.731.4010

The complete catalog contents must be reviewed to ensure that the system designer and user make a safe product selection. When selecting products, the total system design must be considered to ensure safe, trouble-free performance. Function, material compatibility, adequate ratings, proper installation, operation, and maintenance are the responsibilities of the system designer and user. Caution: Do not mix or interchange valve components with those of other manufacturers.