

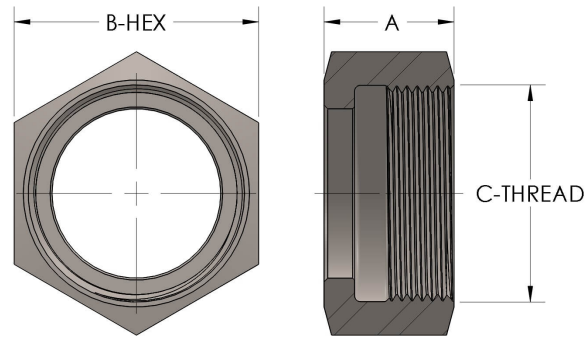

Product Category
Part Description

50N-7-S
Union Nut



DIMENSIONS

A	1.500
B-HEX	3.5
C-THREAD	3.063" - 12UNS

GENERAL

Pressure Rating	6000 PSI
Union Nut Material	Carbon Steel, ASTM A108

cpvmfg.com | 484.731.4010

The complete catalog contents must be reviewed to ensure that the system designer and user make a safe product selection. When selecting products, the total system design must be considered to ensure safe, trouble-free performance. Function, material compatibility, adequate ratings, proper installation, operation, and maintenance are the responsibilities of the system designer and user. Caution: Do not mix or interchange valve components with those of other manufacturers.