

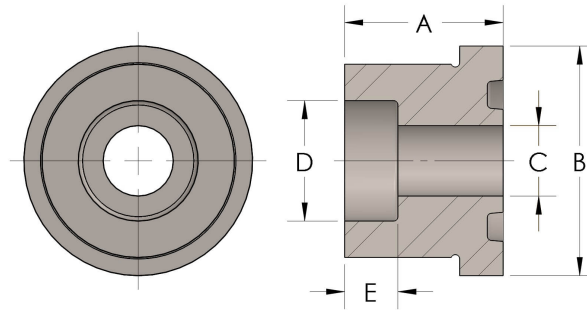

Product Category
Part Description

51R-0-S
Socketweld Pipe



DIMENSIONS

A	0.690
B	0.91
C	0.22
CRN	0A16860.2
D	0.420
E	0.38

GENERAL

Pressure Rating	6000 PSI
Tailpiece Material	Carbon Steel, ASTM A108
O-Ring Material	Viton® Fluorocarbon Type 1, Class 2 (90 durometer)
CRN	0A16860.2

The complete catalog contents must be reviewed to ensure that the system designer and user make a safe product selection. When selecting products, the total system design must be considered to ensure safe, trouble-free performance. Function, material compatibility, adequate ratings, proper installation, operation, and maintenance are the responsibilities of the system designer and user. Caution: Do not mix or interchange valve components with those of other manufacturers.