

Product Category

57-2-1-M

Part Description

Direct Weld/Braze Insert (Male Pipe X Pipe SW)

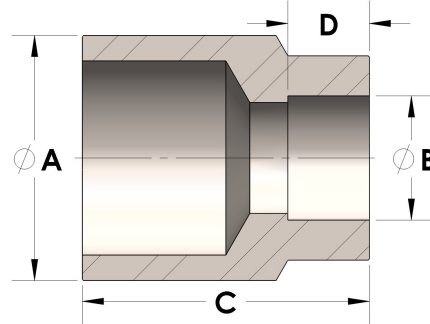

## DIMENSIONS

A	0.675
B	0.56
C	1.31
D	0.380

## GENERAL

Pressure Rating	6000 PSI
Fitting Material	Monel®, ASTM B164, UNS N04405