

Product Category

57-4-1-S

Part Description

Direct Weld/Braze Insert (Male Pipe X Pipe SW)

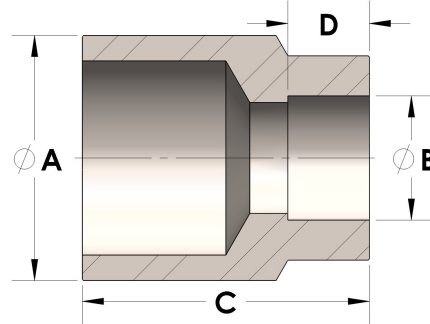

DIMENSIONS

A	1.050
B	0.56
C	1.56
D	0.380

GENERAL

Pressure Rating	6000 PSI
Fitting Material	Carbon Steel, ASTM A108