

Product Category

57-4-2-SS316L

Part Description

Direct Weld/Braze Insert (Male Pipe X Pipe SW)

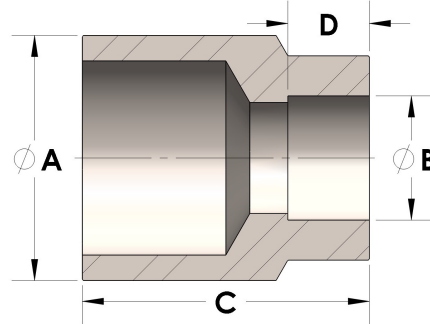

## DIMENSIONS

A	1.050
B	0.69
C	1.63
D	0.440

## GENERAL

Pressure Rating	6000 PSI
Fitting Material	316/L Stainless Steel, ASTM A276, UNS S31600/03