

Product Category

57-7-4-S

Part Description

Direct Weld/Braze Insert (Male Pipe X Pipe SW)

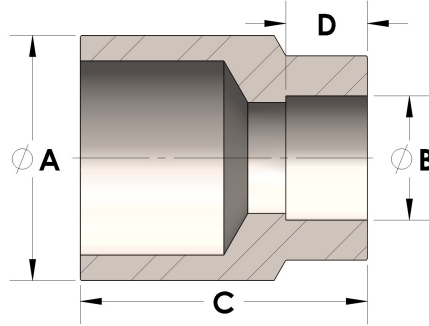

DIMENSIONS

A	1.900
B	1.07
C	1.88
D	0.560

GENERAL

Pressure Rating	6000 PSI
Fitting Material	Carbon Steel, ASTM A108