

Product Category

57-7-5-M

Part Description

Direct Weld/Braze Insert (Male Pipe X Pipe SW)

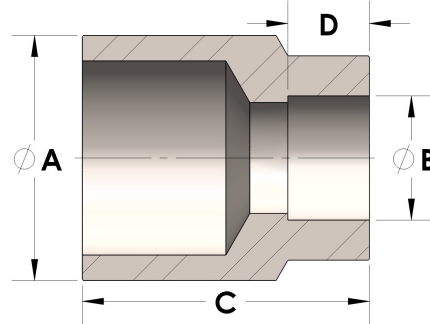

## DIMENSIONS

A	1.900
B	1.33
C	2.00
D	0.630

## GENERAL

Pressure Rating	6000 PSI
Fitting Material	Monel®, ASTM B164, UNS N04405