

Product Category
Product Line
Part Description

670-3
O-SEAL® Check Valves (600 Series)
1/2" Globe Check Valve with Welded Ends

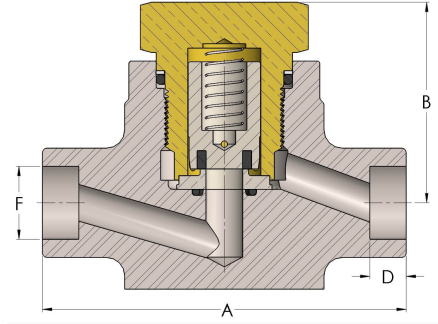

DIMENSIONS

Port Dia.	0.5
A	5.000
B	2.69
D	0.500
F (Pipe Size)	0.855
F (Tube Size)	0.752

GENERAL

Pressure Rating	6000 PSI
Temperature Range	-15°F to 275°F (-26°C to 135°C)
Standard Soft Goods	[-C] Viton® O-Rings
Cartridge Type	Check
Connection Type	Socketweld
Connection Size	1/2"
Body Material	316/L Stainless Steel, ASTM A276, UNS S31603
Bonnet Material	Nickel Aluminum Bronze, ASTM B150, UNS C63200



OPTIONS

Port & Vent Options	[-PA] Port Above Seat (1/8" NPT), [-PB] Port Below Seat (1/8" NPT), '[-VA] Vent Above Seat (3/8"-24 SAE), [-VB] Vent Below Seat (3/8"-24 SAE),
Optional Soft Goods	[-B] Polyurethane® Packing and Buna-N O-Rings, [-C] Viton® Packing & O-Rings, [-D] EPDM Packing & O-Rings