

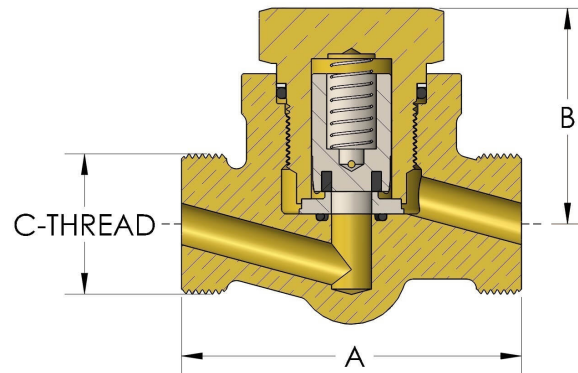

Product Category
Product Line
Part Description

680-1
O-SEAL® Check Valves (600 Series)
1/4" Globe Check Valve with O-SEAL® Ends



DIMENSIONS

Port Dia.	0.31
A	3.380
B	2.00
CRN	0C17716.2
C-THREAD	1.188"-12UN

GENERAL

Pressure Rating	6000 PSI
Temperature Range	-15°F to 275°F (-26°C to 135°C)
Standard Soft Goods	[-C] Viton® O-Rings
Cartridge Type	Check
Connection Type	O-SEAL® Union Thread
Connection Size	1/4"
Body Material	Nickel Aluminum Bronze, ASTM B148, UNS C95800
Bonnet Material	Nickel Aluminum Bronze, ASTM B150, UNS C63200
CRN	0C17716.2

OPTIONS

Port & Vent Options	[-PA] Port Above Seat (1/8" NPT), [-PB] Port Below Seat (1/8" NPT), '[-VA] Vent Above Seat (3/8"-24 SAE), [-VB] Vent Below Seat (3/8"-24 SAE),
Optional Soft Goods	[-B] Polyurethane® Packing and Buna-N O-Rings, [-C] Viton® Packing & O-Rings, [-D] EPDM Packing & O-Rings

cpvmfg.com | 484.731.4010

The complete catalog contents must be reviewed to ensure that the system designer and user make a safe product selection. When selecting products, the total system design must be considered to ensure safe, trouble-free performance. Function, material compatibility, adequate ratings, proper installation, operation, and maintenance are the responsibilities of the system designer and user. Caution: Do not mix or interchange valve components with those of other manufacturers.